

### »» Features

- Mini ISO automotive relay.
- SPNC, SPNO, SPDT, DPNO contact configurations.
- NO contacts switch 50A resistive load, NC contacts switch 30A resistive load, 100,000 ops., 23°C.
- Operating ambient temperature -40°C to 125°C.
- Available with plain cover, flanged cover, bracketed cover, skirted cover, and weather proof cover.
- Available with PCB terminals or quick connect terminals.
- Optional resistor or diode for coil transient suppression.
- Complies with RoHS-Directive 2011/65/EU and ELV-Directive 2000/53/EC.

### »» Type List

Terminal style	Contact form	Enclosure style		
		Dust cover	Flux tight	Sealed type washable
Socket terminal	1A (SPNO)	896-1AH-D	896-1AH-C	896-1AH-S
		896H-1AH-D	896H-1AH-C	896H-1AH-S
	1C (SPDT)	896-1CH-D	896-1CH-C	896-1CH-S
		896H-1CH-D	896H-1CH-C	896H-1CH-S
	2A (DPNO)	896-2AH-D	896-2AH-C	896-2AH-S
		896H-2AH-D	896H-2AH-C	896H-2AH-S
PCB terminal	1A (SPNO)	896P-1AH-D	896P-1AH-C	896P-1AH-S
		896HP-1AH-D	896HP-1AH-C	896HP-1AH-S
	1C (SPDT)	896P-1CH-D	896P-1CH-C	896P-1CH-S
		896HP-1CH-D	896HP-1CH-C	896HP-1CH-S
	2A (DPNO)	896P-2AH-D	896P-2AH-C	896P-2AH-S
		896HP-2AH-D	896HP-2AH-C	896HP-2AH-S

Terminal style	Contact form	Enclosure style	
		Flanged cover (dust cover)	Flanged cover (flux tight)
Socket terminal	1A (SPNO)	896-1AH-D1	896-1AH-C1
		896H-1AH-D1	896H-1AH-C1
	1C (SPDT)	896-1CH-D1	896-1CH-C1
		896H-1CH-D1	896H-1CH-C1
	2A (DPNO)	896-2AH-D1	896-2AH-C1
		896H-2AH-D1	896H-2AH-C1

Terminal style	Contact form	Enclosure style	
		Steel bracket (dust cover)	Steel bracket (flux tight)
Socket terminal	1A (SPNO)	896-1AH-D1S	896-1AH-C1S
		896H-1AH-D1S	896H-1AH-C1S
	1C (SPDT)	896-1CH-D1S	896-1CH-C1S
		896H-1CH-D1S	896H-1CH-C1S
	2A (DPNO)	896-2AH-D1S	896-2AH-C1S
		896H-2AH-D1S	896H-2AH-C1S

Terminal style	Contact form	Designation (provided with)	Enclosure style	
			Steel bracket (dust cover with shroud)	Steel bracket (dust cover with weather proof)
Socket terminal	1C (SPDT)	Resistor	896H-1CH-D1SF-R1	896H-1CH-D1SW-R1

### »» Ordering Information

896            -    1AH    -    C    -        -               

1        2        3        4        5        6        7        8        9

- |   |   |
|---|---|
| 1. 896 -- Basic series designation  | D1S -- Steel bracket (dust cover)   |
| 2. Blank -- Standard type   | C1S -- Steel bracket (flux tight)   |
| H -- High power type  | S1S -- Steel bracket (sealed type washable)   |
| 3. Blank -- Socket terminal   | D1SF -- Steel bracket (dust cover with shroud)  |
| P -- PCB terminal   | D1SW -- Steel bracket (dust cover with weather proof)   |
| 4. 1AH -- Single pole normally open, contact material AgSnO                 | DUSW -- Dust cover with weather proof   |
| 1BH -- Single pole normally closed, contact material AgSnO                  | 6. Blank -- Standard type   |
| 1CH -- Single pole double throw, contact material AgSnO                     | R1 -- Coil parallel with resistor 1/2W for 12V 680Ω , 24V 2700Ω   |
| 2AH -- Double pole double make, contact material AgSnO                      | 7. Blank -- Standard type   |
| 2AUH -- Single pole normally open, contact material AgSnO (2×# 87 terminal) | T -- Special requirement for Tin plated terminal  |
| 5. D -- Dust cover  | 8. Blank -- Standard type   |
| C -- Flux tight   | 001 -- Coil parallel with diode 1N4007 the diode anode on # 85 terminal                                 |
| S -- Sealed type washable   | 002 -- Coil parallel with diode 1N4007 the diode cathode on # 85 terminal                               |
| C1 -- Flanged cover (flux tight)  | 9. <input type="checkbox"/> -- Coil voltage (please refer to the coil rating data for the availability) |
| D1 -- Flanged cover (dust cover)  |   |
| S1 -- Flanged cover (sealed type washable)                                  |   |

## »» Contact Rating

Type	896 1A	896 1B	896 1C	896 2A
Resistive load	40A 14VDC	40A 14VDC	NO : 40A 14VDC NC : 30A 14VDC	2×15A 14VDC

Type	896H 1A	896H 1B	896H 1C	896H 2A
Resistive load	50A 14VDC 20A 28VDC	40A 14VDC 15A 28VDC	NO : 50A 14VDC, 20A 28VDC NC : 30A 14VDC, 15A 28VDC	2×30A 14VDC 2×10A 28VDC

## »» Coil Rating(DC)

Rated voltage (V)	Rated current ±10 % at 23 °C (mA)	Coil resistance ±10 % at 23 °C (Ω)	Max. continuous Voltage at 85 °C <sup>(1)</sup>	Pick up voltage(Max.) at 23 °C	Drop out voltage(Min.) at 23 °C	Power consumption at rated voltage
12	133	90	120 % of rated voltage	65 % of rated voltage	10 % of rated voltage	approx. 1.6W
24	66.7	360				

Notes : (1) Without switching the load.

## »» Specification

Contact material	AgSnO alloy	
Contact voltage drop <sup>(1)</sup>	Typ. 50mV at 10A	
Insulation resistance <sup>(1)</sup>	20MΩ Min. (DC 500V)	
Operate time <sup>(1)</sup>	20ms Max.	
Release time <sup>(1)</sup>	20ms Max.	
Dielectric strength <sup>(1)</sup>	Between open contact	: AC 500V , 50/60Hz 1 min.
	Between contact and coil	: AC 500V , 50/60Hz 1 min.
Vibration resistance	Operating extremes	10~500Hz , 5.0G
	Damage limits	10~500Hz , 5.0G
Shock resistance	Operating extremes	10G
	Damage limits	100G
Life expectancy	Mechanical	10,000,000 operations (frequency 18,000 operations/hr)
	Electrical	100,000 operations (frequency 1,200 operations/hr)
Operating ambient temperature	-40~+125 °C (no freezing)	
Weight	Approx. 40 g	

Note : (1) Initial value. Operate and release time excluding contact bounce.

## »» Outline Dimensions

### ◆ 896,896H (C,D,S)

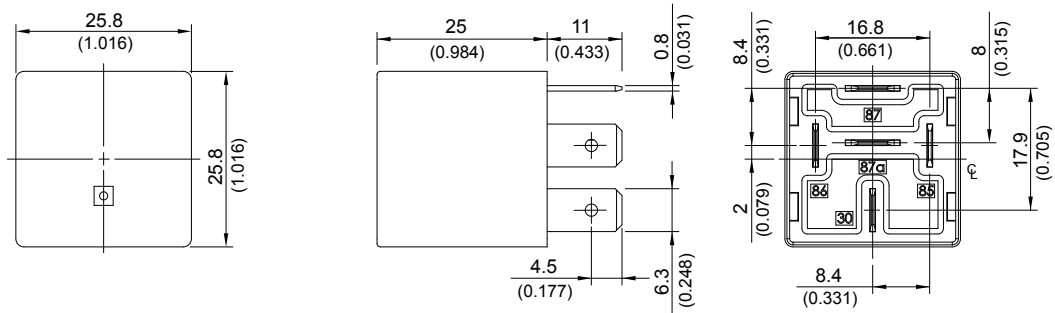

### ◆ 896,896H (C1,D1,S1)

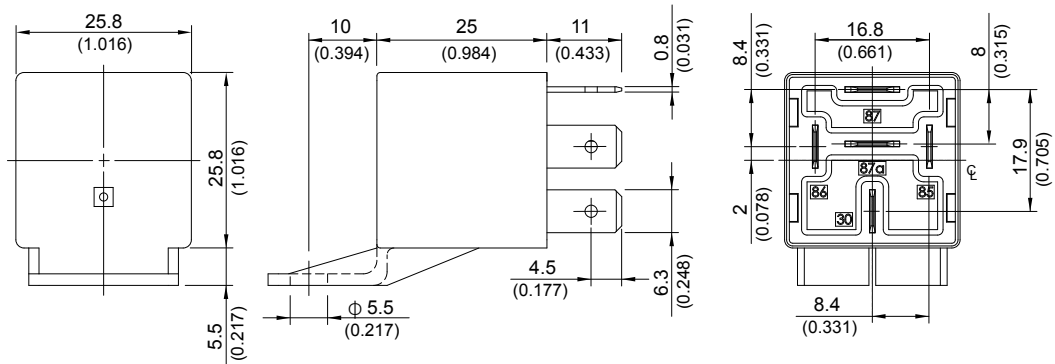

### ◆ 896,896H (C1S,D1S,S1S)

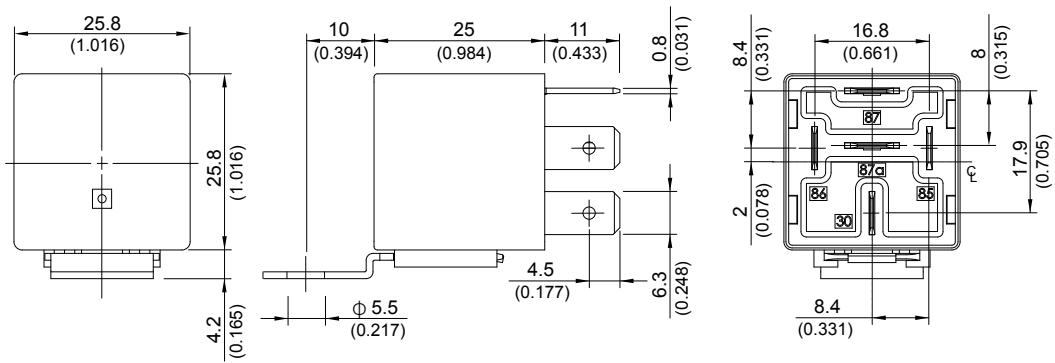

### ◆ 896P,896HP (C,D,S)

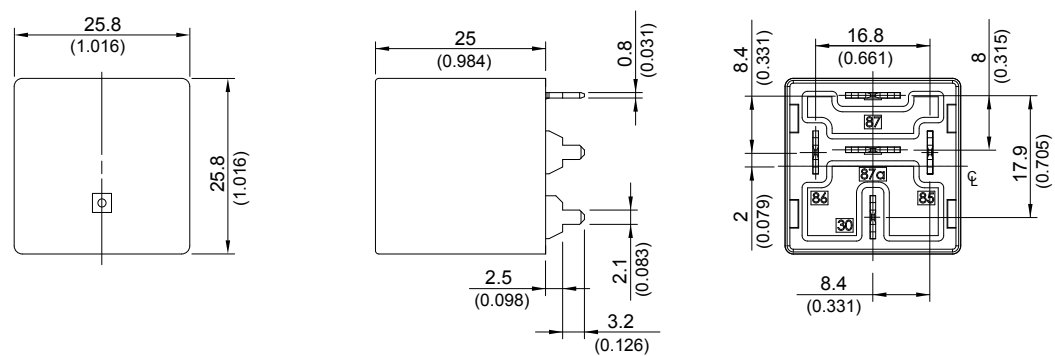

◆896H (D1SF)

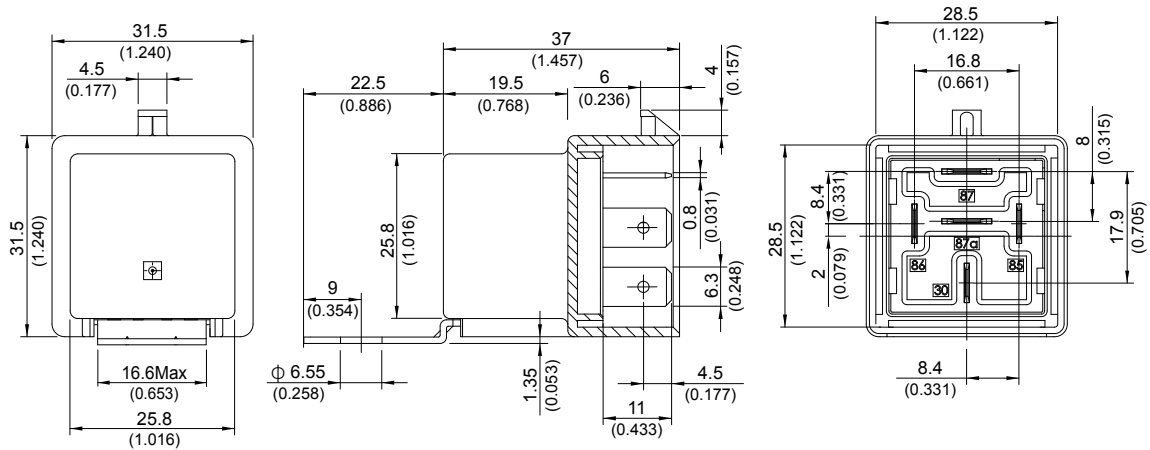

◆896H (D1SW)

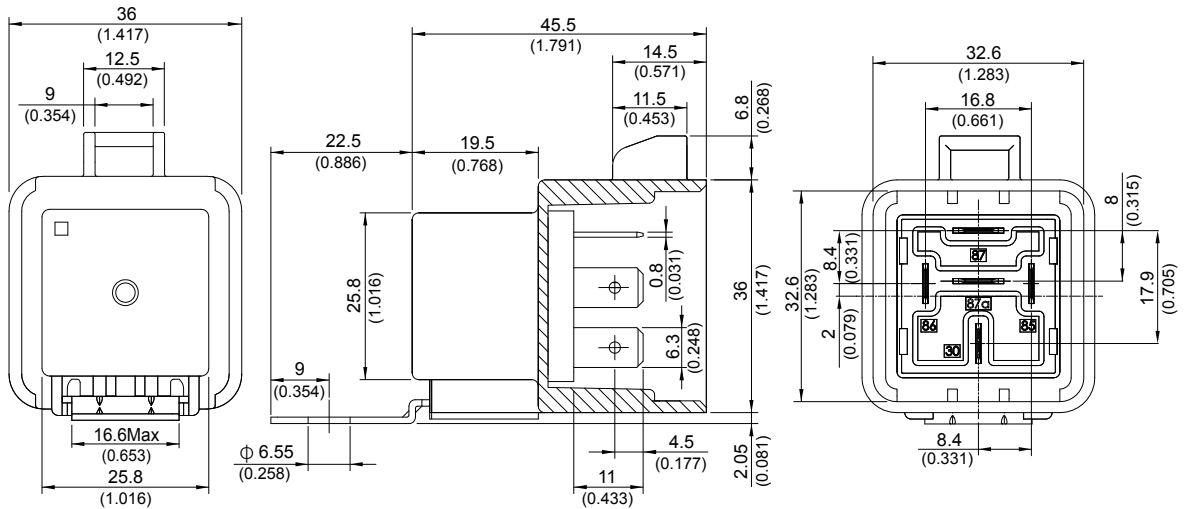

◆896H (DUSW)

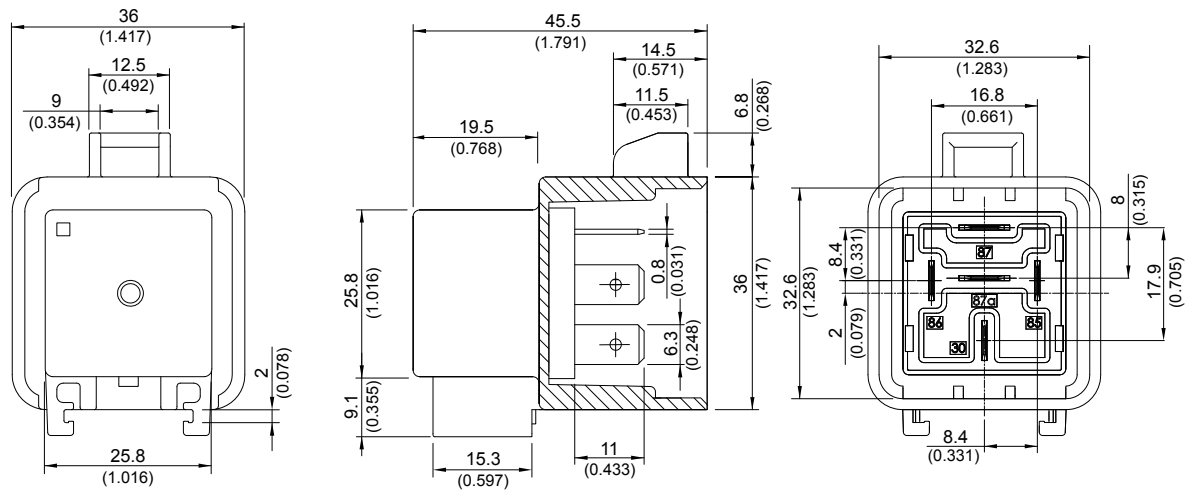

TOLERANCE:  
 LESS THAN: 1(0.039)  $\pm$ 0.1(0.004)  
 5(0.197)  $\pm$ 0.3(0.012)  
 20(0.787)  $\pm$ 0.5(0.020)  
 MORE THAN: 20(0.787)  $\pm$ 1(0.039)

## Wiring Diagram BOTTOM VIEW

1A

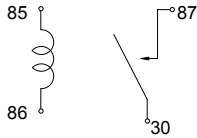

1B

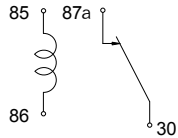

1C

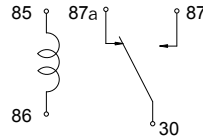

2AU

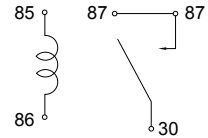

2A

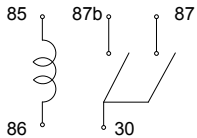

R1

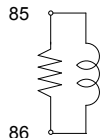

001

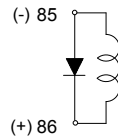

002

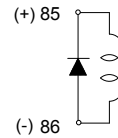

## PC Board Layout BOTTOM VIEW

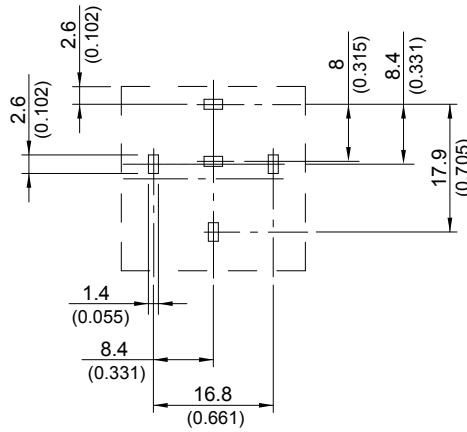

## Engineering Data

Safe breaking, arc extinguished  
(normally open contact) for resistive loads (896H)

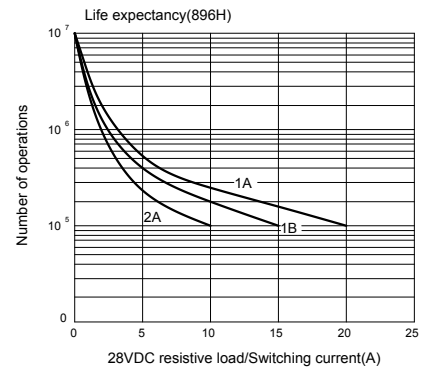
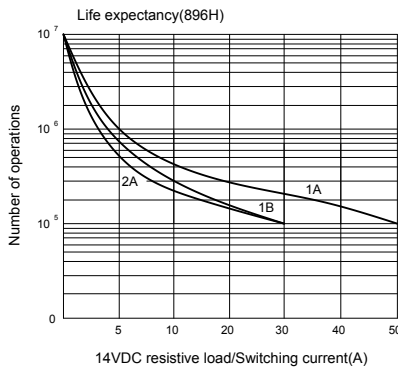
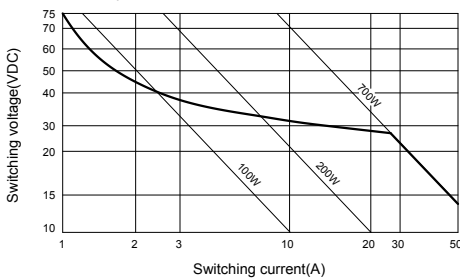

Ambient temperature vs coil voltage for continuous duty

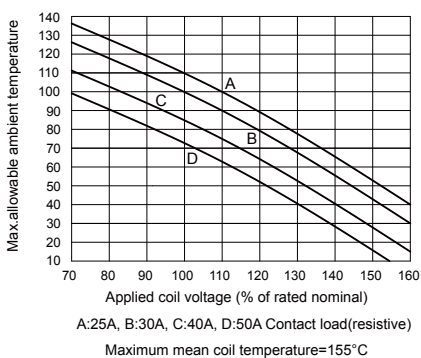

Operate time/Release time

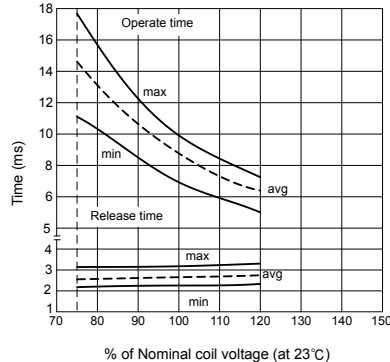

Max. DC load breaking capacity

